

# 835E10

## Biloba Evo oildynamic hinge

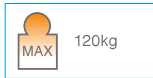
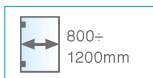
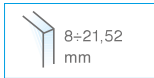
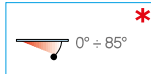

• Cerniera oleodinamica vetro-muro per porte in battuta, con velocità di chiusura regolabile e controllo costante di frenatura; permette un'apertura della porta fino a 180°. Stop a +90° +180°. **Si installa su porte con profilo in battuta. Profondità stipite da 30 a 50 mm.**

• Bisagra automática hidráulica vidrio-pared para puerta con tope; regulación de velocidad de cierre de la puerta y control constante de frenado; la puerta se puede abrir hasta 180°. Stop a +90° +180°. **Se instala en puertas con perfil con batida. Profundidad estipite entre 30 y 50 mm.**

• Hydraulic hinge glass to wall for doors with stop, with adjustable closing speed and constant braking control; the door opens up to 180°. Stop at +90° +180°. **Installed on doors with a profile on a stop. Jamb depth from 30 to 50 mm.**

• Hydraulikband Glas-Wand für Anschlagtüren, mit regulierbar Schließgeschwindigkeit und konstanter Kontrolle der Bremsung; Öffnung der Tür bis 180°. Feststellung +90° +180°. **Man kann es auf Türen mit Rahmen benutzen. Pfostentiefe von 30 bis 50 mm.**

• Charnière hydraulique verre-mur pour porte à butée avec contrôle constant de la vitesse de fermeture : permet une ouverture de la porte jusqu'à 180°. Stop à +90° +180°. **S'installe sur profil de porte. Profondeur du jambage de 30 à 50 mm.**

**835E10 R** = destra - derecha - right - rechts - droite  
**835E10 L** = sinistra - izquierda - left - links - gauche

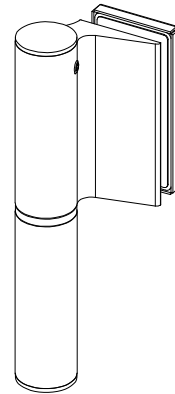

\* • È necessaria una battuta in chiusura in quanto la cerniera ha una pre-carica. • Necesita de un cierre con tope, puesto que la bisagra tiene una precarga. • The hinge has a loading and it is therefore necessary a closing stop. • Eine Schließfeststellung ist notwendig, weil das Scharnier eine mechanische Belastung hat. • La charnière a une charge, il est donc nécessaire d'avoir un arrêt de fermeture.

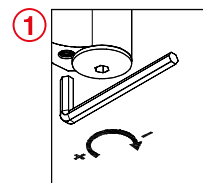
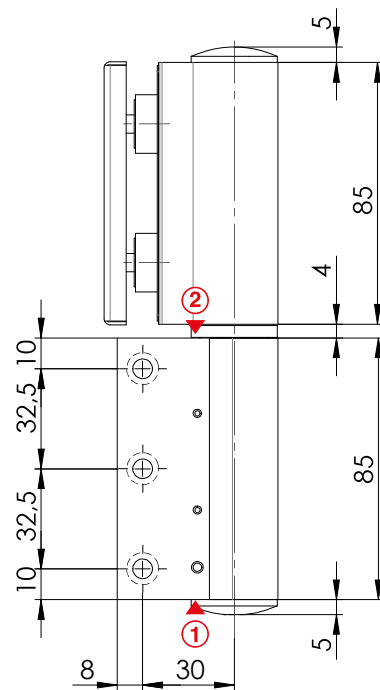
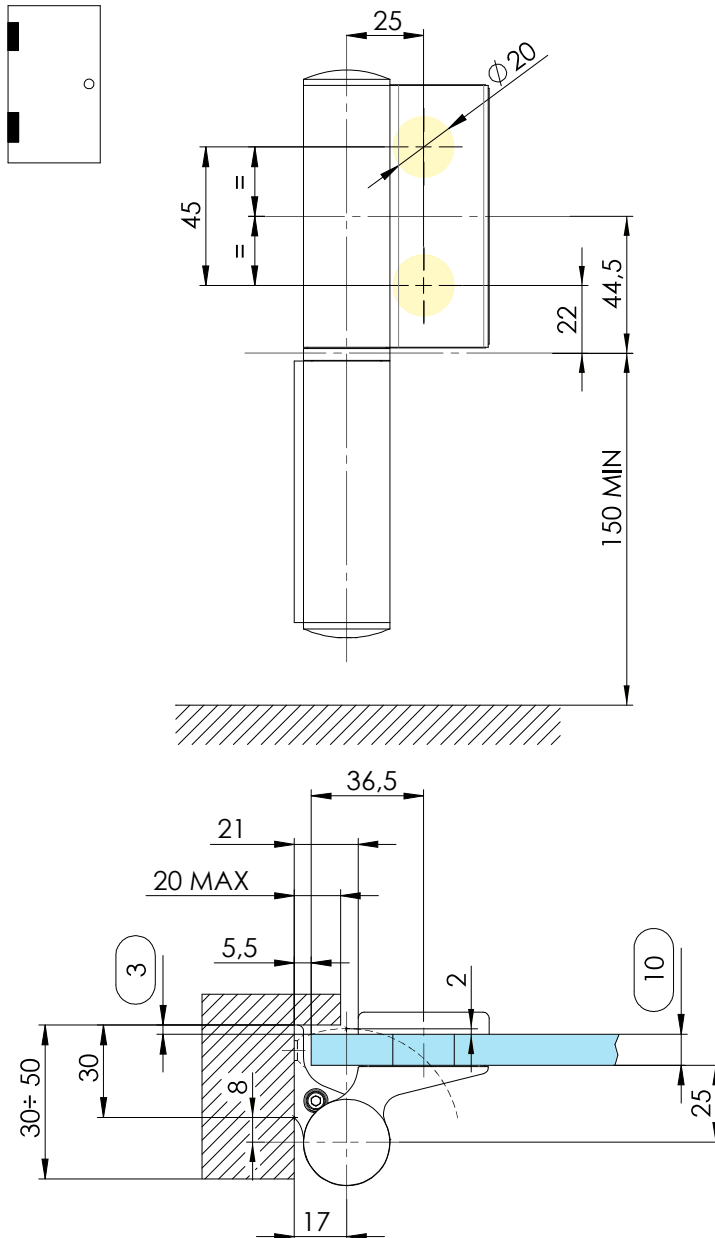

Regolazione scatto finale  
Ajuste del resorte final  
Final latch adjustment  
Regulierung der Endschwung  
Réglage de verouillage final

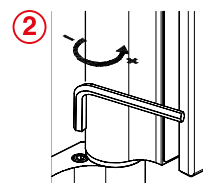

Regolazione della velocità di chiusura  
Ajuste de la velocidad de cierre  
Closing speed adjustment  
Regulierung der Schließgeschwindigkeit  
Réglage de la vitesse de fermeture